

A+R



PROGRESSIVE



LINE

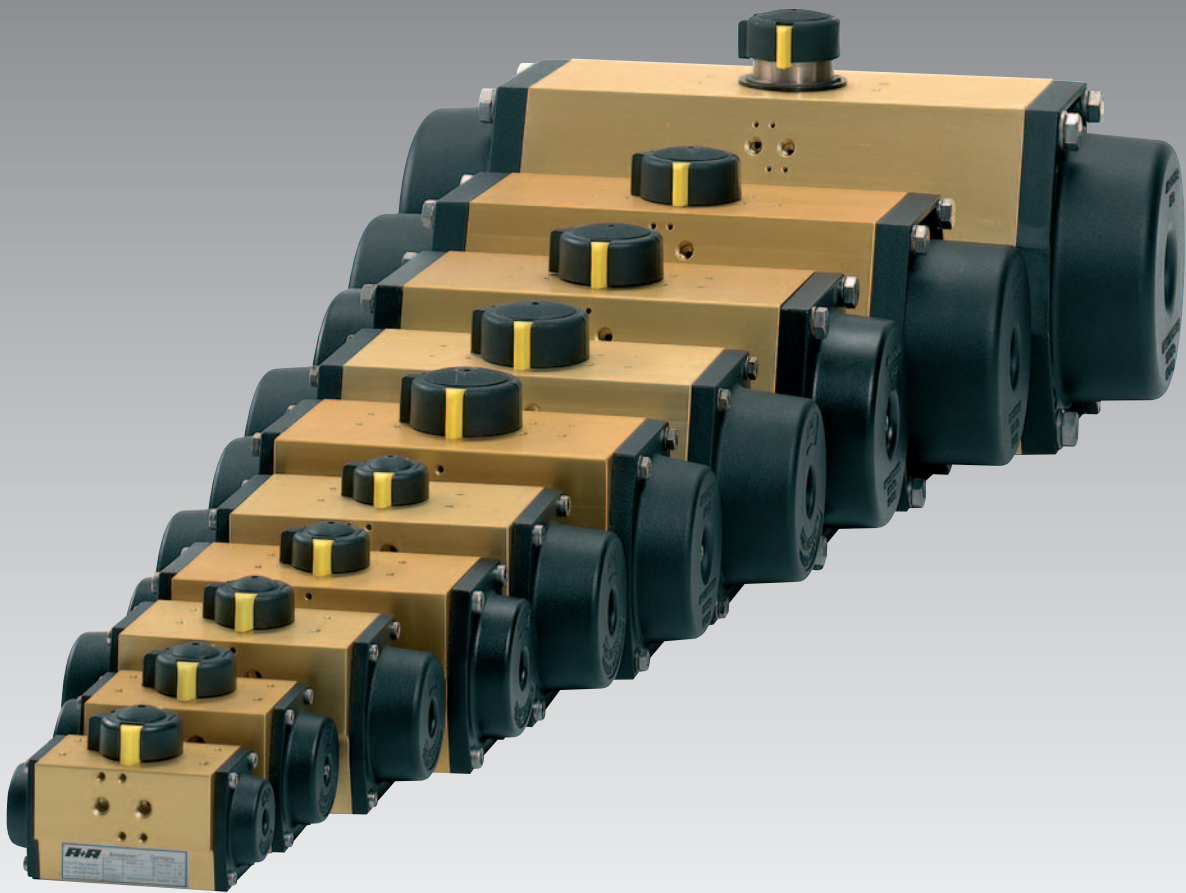

A+R

SCHWENKANTRIEBE
PNEUMATIC ACTUATORS

Doppelkolben-Schwenkantrieb / Pneumatic Actuator

Typ ARSD / ARSE

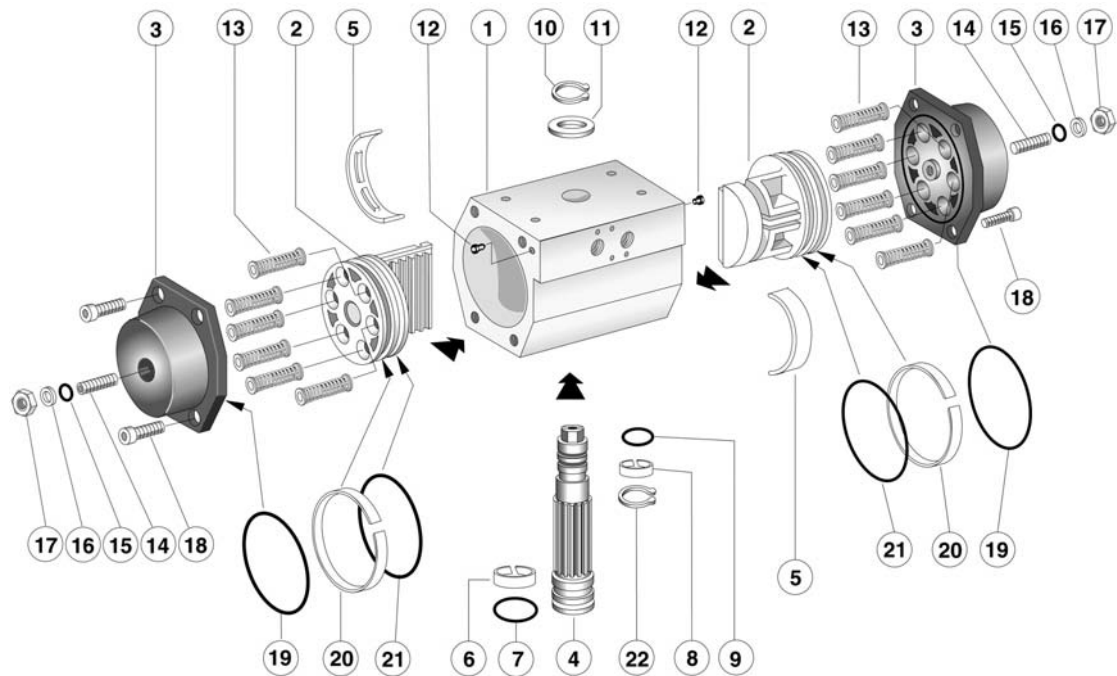

22	Sicherungsring	spring clip	1	VA	stainless steel
▶ 21	O-Ring	o-ring	2	Buna-N	Buna-N
▶ 20	Kolbenband	piston guide	2	Acetal Resin	Acetal Resin
▶ 19	O-Ring	o-ring	2	Buna-N	Buna-N
18	Schraube	screw	8	VA	stainless steel
17	Mutter	nut	2	VA	stainless steel
16	Scheibe	plain washer	2	VA	stainless steel
15	O-Ring	o-ring	2	Buna-N	Buna-N
14	Schraube	screw	2	VA	stainless steel
13	Federn*	springs*	4-12	Stahl behandelt	carbon steel treated
▶ 12	Stopfen	plug	2	Gummi	rubber
11	Gleitring	thrust washer	1	Acetal Resin	Acetal Resin
10	Sicherungsring	spring clip	1	VA	stainless steel
▶ 9	O-Ring	o-ring	1	Buna-N	Buna-N
▶ 8	Gleitring	pinion guide	1	Acetal Resin	Acetal Resin
▶ 7	O -Ring	o-ring	1	Buna-N	Buna-N
▶ 6	Gleitring	pinion guide	1	Acetal Resin	Acetal Resin
▶ 5	Gleitelement	piston guide	2	Acetal Resin	Acetal Resin
4	Ritzel	pinion	1	Stahl behandelt	carbon steel treated
3	Deckel	end cap	2	Aluminium-Legierung	aluminium alloy
2	Kolben	piston	2	Aluminium-Legierung	aluminium alloy
1	Gehäuse	body	1	Aluminium-Legierung	aluminium alloy
Pos. / item	Benennung / denomination		Stück / pieces	Werkstoff	material

* Typ ARSE, vorgespannte Federn / type ARSE, preloaded springs

Typenauswahl / type selection				Wartung / maintenance	
ARS	D -	4 -	100	Schwenkantriebe Typ ARS werden betriebsbereit geliefert und sind wartungsfrei. Als Reparaturset empfehlen wir die mit einem ▶ markierten Positionen.	
Typ	doppeltwirkend	Baureihe	Kolben Ø		
type	double acting	series-no.	piston Ø		
ARS	E -	5 -	125 -	S4	Actuators type ARS are delivered ready for operation. Maintenance normally is not necessary. We suggest spare parts marked with ▶ as repair-set.
Typ	einfachwirkend	Baureihe	Kolben Ø	Federn pro Kolben	
type	spring return	series-no.	piston Ø	springs per piston	

Doppelkolben-Schwenkantrieb / Pneumatic Actuator

Typ ARSD / ARSE

Drehmomente [Nm] einfachwirkende Antriebe ARSE / Torque output [Nm] spring return actuators ARSE															
Typ / type	Federn pro Kolben / springs per piston	Steuerdruck [bar] / operating pressure [bar]												Federkraft / spring - stroke	
		3		4		5		6		7		8			
		0°	90°	0°	90°	0°	90°	0°	90°	0°	90°	0°	90°	90°	0°
ARSE-1-25	S2	6,5	5,4	9,4	8,3	12,0	11,0	15,0	14,0	19,0	18,0	22,0	21,0	3,5	2,4
	S3	5,3	3,7	8,2	6,6	11,0	9,6	14,0	13,0	18,0	17,0	21,0	20,0	5,2	3,6
	S4	4,1	1,9	7,0	4,8	10,0	7,8	13,0	11,0	17,0	15,0	20,0	18,0	7,0	4,8
	S5	=	=	3,1	2,7	8,8	6,1	12,0	9,0	16,0	13,0	19,0	16,0	8,7	6,0
	S6	=	=	=	=	7,6	4,3	11,0	7,2	15,0	11,0	18,0	14,0	11,0	7,2
ARSE-2-63	S2	10,0	8,5	15,0	13,0	20,0	18,0	24,0	23,0	29,0	27,0	34,0	32,0	5,6	3,8
	S3	8,4	5,7	13,0	10,0	18,0	15,0	23,0	20,0	27,0	25,0	32,0	29,0	8,4	5,7
	S4	=	=	11,0	7,6	16,0	12,0	21,0	17,0	25,0	22,0	30,0	26,0	11,2	7,6
	S5	=	=	=	=	14,0	9,5	19,0	14,0	23,0	19,0	28,0	24,0	14,0	9,5
	S6	=	=	=	=	12,0	6,7	17,0	11,0	22,0	16,0	26,0	21,0	17,0	11,0
ARSE-3-75	S2	22,0	18,0	32,0	28,0	42,0	38,0	52,0	48,0	62,0	58,0	72,0	68,0	12,0	8,0
	S3	18,0	12,0	28,0	22,0	38,0	32,0	48,0	42,0	58,0	52,0	68,0	62,0	18,0	12,0
	S4	=	=	24,0	16,0	34,0	26,0	44,0	36,0	54,0	46,0	64,0	56,0	24,0	16,0
	S5	=	=	=	=	30,0	20,0	40,0	30,0	50,0	40,0	60,0	50,0	30,0	20,0
	S6	=	=	=	=	26,0	14,0	36,0	24,0	46,0	34,0	56,0	44,0	36,0	24,0
ARSE-3.5-85	S2	42,0	30,0	59,0	47,0	76,0	64,0	93,0	81,0	110,0	98,0	127,0	115,0	21,0	9,5
	S3	32,0	20,0	49,0	37,0	66,0	54,0	83,0	71,0	100,0	88,0	117,0	105,0	31,0	19,0
	S4	=	=	43,0	20,0	60,0	37,0	77,0	54,0	94,0	71,0	111,0	88,0	48,0	25,0
	S5	=	=	=	=	53,0	33,0	70,0	50,0	87,0	67,0	104,0	84,0	52,0	32,0
	S6	=	=	=	=	47,0	22,0	64,0	39,0	81,0	56,0	106,0	73,0	63,0	38,0
ARSE-4-100	S2	53,0	42,0	77,0	66,0	101,0	90,0	124,0	113,0	150,0	139,0	174,0	175,0	29,0	18,0
	S3	43,0	28,0	67,0	52,0	91,0	76,0	114,0	99,0	140,0	125,0	164,0	154,0	43,0	28,0
	S4	=	=	58,0	38,0	82,0	62,0	105,0	85,0	131,0	111,0	155,0	132,0	57,0	37,0
	S5	=	=	=	=	73,0	47,0	96,0	70,0	122,0	96,0	146,0	110,0	72,0	46,0
	S6	=	=	=	=	64,0	33,0	87,0	56,0	113,0	82,0	137,0	89,0	86,0	55,0
ARSE-4.5-115	S2	97,0	78,0	104,0	121,0	184,0	165,0	228,0	208,0	271,0	252,0	315,0	296,0	53,0	34,0
	S3	80,0	51,0	123,0	95,0	167,0	138,0	211,0	182,0	254,0	225,0	298,0	269,0	80,0	51,0
	S4	63,0	24,0	106,0	68,0	150,0	111,0	194,0	155,0	237,0	199,0	281,0	242,0	107,0	68,0
	S5	=	=	89,0	41,0	133,0	85,0	177,0	128,0	220,0	172,0	264,0	216,0	133,0	85,0
	S6	=	=	72,0	14,0	116,0	58,0	160,0	102,0	203,0	145,0	247,0	189,0	160,0	102,0
ARSE-5-125	S2	124,0	99,0	179,0	154,0	235,0	210,0	290,0	265,0	345,0	321,0	401,0	376,0	68,0	43,0
	S3	103,0	66,0	158,0	121,0	214,0	177,0	269,0	232,0	325,0	288,0	380,0	343,0	101,0	64,0
	S4	=	=	136,0	87,0	192,0	143,0	247,0	198,0	303,0	254,0	358,0	309,0	135,0	86,0
	S5	=	=	=	=	170,0	109,0	225,0	164,0	281,0	220,0	336,0	275,0	169,0	108,0
	S6	=	=	=	=	148,0	75,0	203,0	130,0	259,0	186,0	314,0	241,0	203,0	130,0
ARSE-5.5-140	S2	176,0	133,0	259,0	215,0	338,0	294,0	416,0	373,0	495,0	452,0	574,0	531,0	100,0	57,0
	S3	148,0	83,0	230,0	165,0	309,0	244,0	388,0	323,0	467,0	402,0	546,0	481,0	150,0	85,0
	S4	120,0	33,0	202,0	115,0	281,0	194,0	360,0	273,0	439,0	352,0	517,0	431,0	200,0	113,0
	S5	=	=	174,0	65,0	253,0	144,0	331,0	223,0	410,0	302,0	489,0	381,0	250,0	142,0
	S6	=	=	145,0	15,0	224,0	94,0	303,0	173,0	382,0	252,0	461,0	331,0	300,0	170,0
ARSE-6-160	S2	257,0	200,0	371,0	314,0	484,0	427,0	597,0	540,0	712,0	655,0	825,0	768,0	140,0	83,0
	S3	215,0	130,0	329,0	244,0	442,0	357,0	555,0	470,0	670,0	585,0	783,0	698,0	210,0	125,0
	S4	=	=	287,0	174,0	400,0	287,0	513,0	400,0	628,0	515,0	741,0	628,0	280,0	167,0
	S5	=	=	=	=	358,0	217,0	471,0	330,0	586,0	445,0	699,0	558,0	350,0	209,0
	S6	=	=	=	=	316,0	147,0	429,0	260,0	544,0	375,0	657,0	488,0	420,0	251,0
ARSE-8-200	S2	478,0	386,0	691,0	599,0	904,0	812,0	1120,0	1020,0	1330,0	1240,0	1700,0	1450,0	252,0	160,0
	S3	398,0	260,0	611,0	473,0	824,0	686,0	1040,0	898,0	1250,0	1110,0	1460,0	1300,0	378,0	240,0
	S4	=	=	531,0	347,0	744,0	560,0	956,0	772,0	1170,0	987,0	1380,0	1200,0	504,0	320,0
	S5	=	=	=	=	664,0	434,0	876,0	646,0	1090,0	861,0	1300,0	1070,0	630,0	400,0
	S6	=	=	=	=	584,0	308,0	796,0	520,0	1010,0	735,0	1220,0	948,0	756,0	480,0
ARSE-10-250	S2	1181,0	957,0	1720,0	1496,0	2259,0	2035,0	2798,0	2574,0	3337,0	3113,0	3876,0	3652,0	660,0	436,0
	S3	963,0	628,0	1502,0	1167,0	2041,0	1706,0	2580,0	2245,0	3119,0	2784,0	3658,0	3323,0	989,0	654,0
	S4	=	=	1284,0	837,0	1823,0	1376,0	2362,0	1915,0	2901,0	2454,0	3440,0	2993,0	1319,0	872,0
	S5	=	=	=	=	1605,0	1046,0	2144,0	1585,0	2683,0	2124,0	3222,0	2663,0	1649,0	1090,0
	S6	=	=	=	=	=	=	1909,0	1254,0	2448,0	1793,0	2987,0	2332,0	1980,0	1325,0

Drehmomente [Nm] doppeltwirkende Antriebe ARSD / Torque output [Nm] double acting actuators ARSD								
Typ / type	Steuerdruck [bar] / operating pressure [bar]							
	2	3	4	5	6	7	8	
ARSD-1-25	5,9	8,9	12,0	15,0	18,0	22,0	25,0	
ARSD-2-63	9,4	14,0	19,0	24,0	28,0	33,0	38,0	
ARSD-3-75	20,0	30,0	40,0	50,0	60,0	70,0	80,0	
ARSD-3.5-85	34,0	51,0	68,0	85,0	102,0	119,0	136,0	
ARSD-4-100	48,0	71,0	95,0	119,0	142,0	168,0	192,0	
ARSD-4.5-115	87,0	131,0	174,0	218,0	262,0	305,0	349,0	
ARSD-5-125	111,0	167,0	222,0	278,0	333,0	389,0	444,0	
ARSD-5.5-140	158,0	236,0	315,0	394,0	473,0	552,0	631,0	
ARSD-6-160	227,0	340,0	454,0	567,0	680,0	795,0	908,0	
ARSD-8-200	426,0	638,0	851,0	1060,0	1280,0	1490,0	1700,0	
ARSD-10-250	1078,0	1617,0	2156,0	2695,0	3234,0	3773,0	4312,0	

Doppelkolben-Schwenkantrieb / Pneumatic Actuator

Typ ARSD / ARSE

- Pneumatische Doppelkolben-Schwenkantriebe, Schwenkwinkel 90°, einfach- und doppelwirkende Ausführung.
- Kraftübertragung Zahnstangenprinzip, Endanschläge einstellbar ± 3°, Typ ARSE mit vorgespannten Federn.
- Steuerdruck 2-10 bar (ARSD) bzw. 3-10 bar (ARSE), Temperaturbereich -20 °C bis +80 °C.
- Steuermedium gereinigte Luft, geölt oder trocken, neutrale Gase, Antriebe sind wartungsfrei vorgeschmiert.
- Beliebige Einbaulage, Innen- und Außeneinsatz möglich.
- Peripherieanschlüsse gem. ISO 5211, DIN 3337, VDI/VDE 3845, NAMUR-Empfehlung.
- 11 verschiedene Antriebsgrößen (2-4300 Nm) für exakte anwendungsgerechte Auslegung.

- Pneumatic actuators, stroke 90°, double acting and spring return.
- Rack and pinion design, travel-stops adjustable ± 3°, preloaded springs for type ARSE.
- Operating pressure 2-10 bar (ARSD) or 3-10 bar (ARSE), temperature-range -20 °C to + 80 °C.
- Operating media filtered dry or lubricated air, non-corrosive gas, moving parts are lubricated for cycle life of actuators.
- Mountable in any position, suitable for indoor and outdoor using.
- Peripheral connections acc. to ISO 5211, DIN 3337, VDI/VDE 3845, NAMUR.
- 11 different actuator sizes (2-4300 Nm) for exact choice acc. to application.

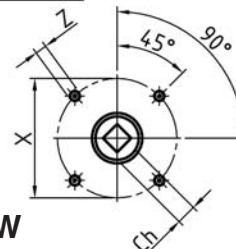
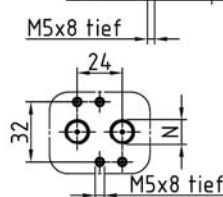
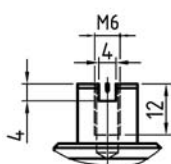
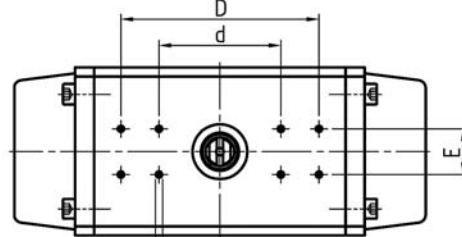
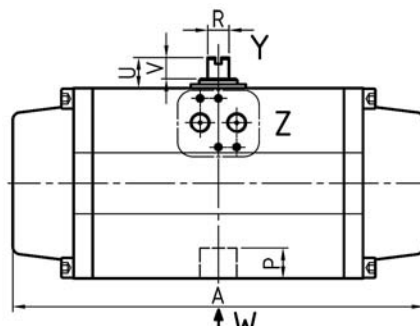
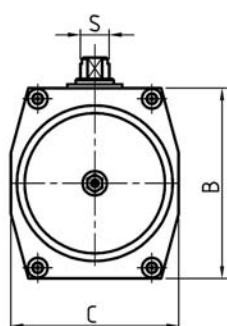

Protokollierung von Öffnungs / Schließzeiten von komplett aufgebauten Armatureneinheiten möglich.

Recording of opening / closing time of complete valve-units possible.

Y Verbindung zu Signalgeräten entspr. VDI/VDE 3845
Connection for limit switches acc. to VDI/VDE 3845

Z Magnetventilanschluss nach NAMUR Standard
Solenoid valve connection acc. to NAMUR Standard

W Armatureanschluss gem. ISO 5211
Valve connection acc. to ISO 5211

Typ / Type	Luftverbrauch [dm³] / air-consumption [dm³]		Öffnungs / Schließzeit [s] / opening / closing time [s]		
	↶	↷	Typ / Type	ARSD	ARSE
ARS-1-25	0,08	0,10	ARS-1-25	< 0,5	< 0,5
ARS-2-63	0,12	0,16	ARS-2-63	< 1	< 1
ARS-3-75	0,24	0,44	ARS-3-75	< 1	< 1
ARS-3.5-85	0,48	0,56	ARS-3.5-85	< 1	< 1
ARS-4-100	0,68	0,96	ARS-4-100	< 1	< 1
ARS-4.5-115	1,00	1,60	ARS-4.5-115	< 1	< 1
ARS-5-125	1,40	2,16	ARS-5-125	< 1,25	1,5-2
ARS-5.5-140	1,60	2,56	ARS-5.5-140	< 1,5	< 2
ARS-6-160	3,20	4,00	ARS-6-160	1,5-2	2-3
ARS-8-200	5,30	8,60	ARS-8-200	3-4	4-6
ARS-10-250	14,20	16,50	ARS-10-250	5-6	7-8

Typ / Type	A	B	C	D	d	E	N	P	S	Z	U	V	CH	X	R	ISO 5211	Gew. / Kg
ARS...1-25	142	67	60	-	80	30	1/8"	10	12	M5/M6	20	10	9	36/50	8	F03/F05	1,15
ARS...2-63	155	83	73	-	80	30	1/4"	12	12	M5/M6	20	10	11	42/50	8	F04 od F05	1,6
ARS...3-75	213	100	85	-	80	30	1/4"	16	14	M6/M8	20	10	14	50/70	10	F05/F07	2,8
ARS...3.5-85	236	110	98	-	80	30	1/4"	20	19	M8	20	13	17	70	14	F07	4,3
ARS...4-100	276	125	110	-	80	30	1/4"	20	19	M8/M10	20	13	17	70/102	14	F07/F10	5,8
ARS...4.5-115	310	142	128	130	80	30	1/4"	24	28	M10	30	20	22	102	20	F10	8,3
ARS...5-125	366	155	140	130	80	30	1/4"	24	28	M10	30	20	22	102	20	F10	11,6
ARS...5.5-140	388	176	160	130	80	30	1/4"	29	36	M12	30	20	27	125	28	F12	14,2
ARS...6-160	468	200	175	130	80	30	1/4"	29	36	M12	30	20	27	125	28	F12	21,7
ARS...8-200	563	250	215	130	-	30	1/4"	38	48	M16	50	20	36	140	32	F14	40,1
ARS...10-250	750	335	290	130	-	30	1/4"	50	48	M20	50	20	46	165	32	F16	110

A+R - Armaturen® GmbH

D-32107 Bad Salzufflen / Germany

Altenhagener Straße 4a • Telefon +49(0)5208-9102-0
• Telefax +49(0)5208-9102-90

A+R im Internet:

www.ar-armaturen.com

e-mail: postoffice@ar-armaturen.com