



Industrial position sensor for very long measurement ranges

- Protection class IP52
- Measurement ranges 0 ... 60000 mm
- Absolute or incremental encoder



Specifications	Outputs	Incremental encoder with TTL or HTL output Absolute encoder see order code
Resolution	8 pulses/steps per mm	
Linearity	±0.10 % f.s.; optional 0.025 % f.s.	
Sensing device	Absolute encoder / incremental encoder	
Material	Aluminium and stainless steel; Cable: stainless steel	
Protection class	IP52, encoder IP64	
Connection	Depending at the encoder type: connector or bus cover	
Weight	Approx. 15 kg maximum	
EMC, temperature	Refer to output specification	

Order code WS60

Model name

Measurement range (in mm)

60000

Outputs

- LD5VC = Incremental encoder TTL compatible
- PP24VC = Incremental encoder HTL compatible
- HSSI = Absolute encoder with synchronous serial output (SSI)
- HPROF = Absolute encoder with Profibus interface
- HINT = Absolute encoder with Interbus interface
- HDEV = Absolute encoder with DeviceNet interface
- HCAN = Absolute encoder with CAN interface
- HCANOP = Absolute encoder with CANopen interface

Linearity (option)

L025 = ±0.025% f.s.

Cable fixing

- M4 = M4 cable fixing
- SB0 = Cable clip



Order code mating connector

incremental, SSI:

CONN-CONIN-12F-G

Order example: WS60 - 60000 - HSSI - M4

Cable forces, typical at 20 °C	Range	Max. pull-out force	Min. pull-in force
	[mm]	[N]	[N]
	60000	17.0	6.5

Outline drawing
WS60-60000

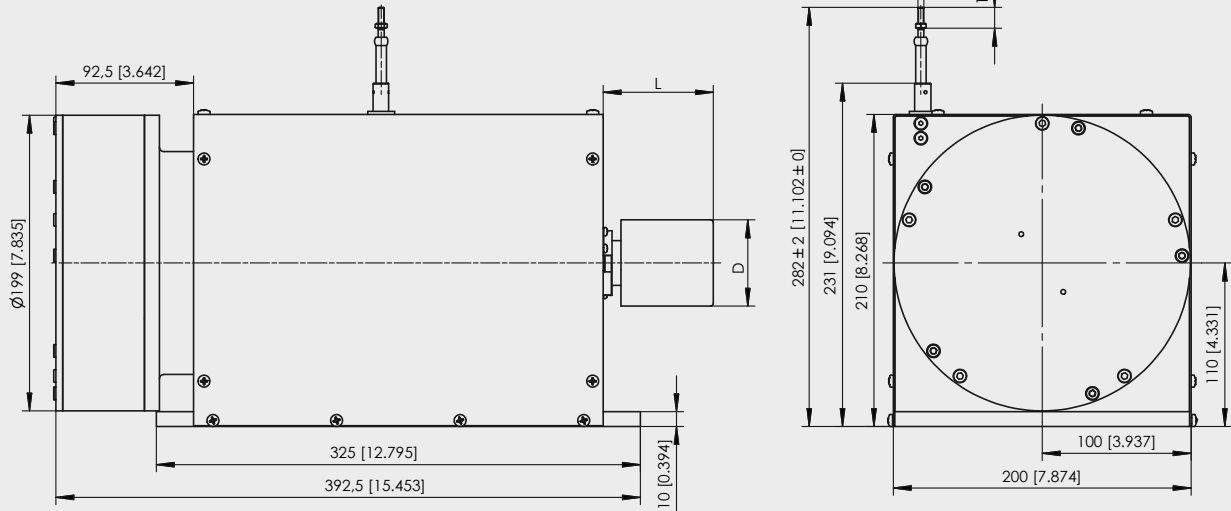

Dimensions D and L depend on the encoder type

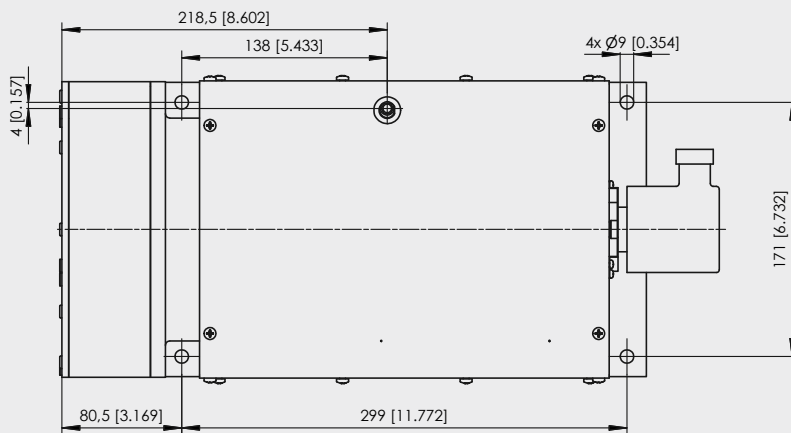

Dimensions in mm [inch]

Dimensions informative only.
For guaranteed dimensions
consult factory.

POSIWIRE®

LD5VC and PP24VC

Incremental Output

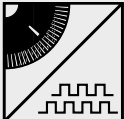

Signal conditioner LD5VC Incremental 	Interface	Line driver RS422
	Excitation voltage	5 V DC $\pm 10\%$
	Excitation current	150 mA max. w/o load
	Output frequency	300 kHz max.
	Output current	20 mA per channel
	Signal level	
	Ud High at Id=20 mA	≥ 2.5 V
	Ud Low at Id=20 mA	≤ 0.5 V
	Transition time positive edge	<100 ns
	Transition time negative edge	<100 ns
	Stability (temperature)	$\pm 20 \times 10^{-6}$ / °C f.s. (sensor mechanism)
	Operation temperature	-20 ... +85 °C
	Protection	Short circuit, overvoltage
EMC	According to EN 61326:2006	

Signal conditioner PP24VC Incremental 	Interface	Push-pull line driver (24 V-HTL)
	Excitation voltage	10 ... 30 V DC
	Excitation current	150 mA max. w/o load
	Output frequency	300 kHz max.
	Output current	100 mA per channel
	Signal level	
	Ud High at Id=20 mA, Ub=24 V	≥ 21 V
	Ud Low at Id=20 mA, Ub=24 V	≤ 2.8 V
	Transition time positive edge	<200 ns
	Transition time negative edge	<200 ns
	Stability (temperature)	$\pm 20 \times 10^{-6}$ / °C f.s. (sensor mechanism)
	Operating temperature	-20 ... +85 °C
	Protection	Reverse polarity, short circuit, overvoltage
EMC	According to EN 61326:2006	

Output signals

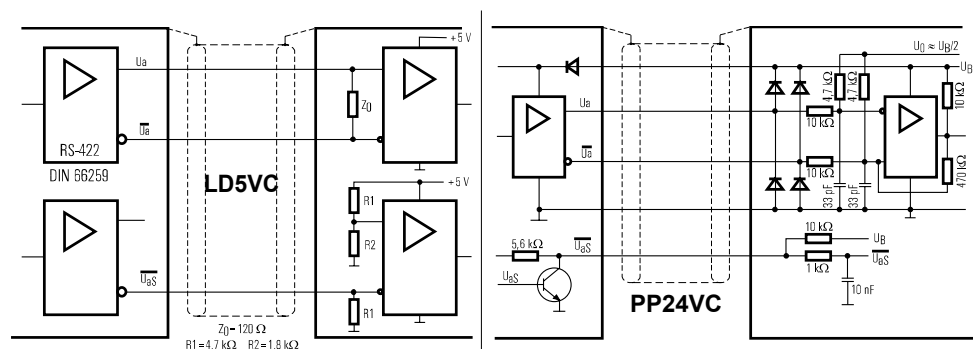
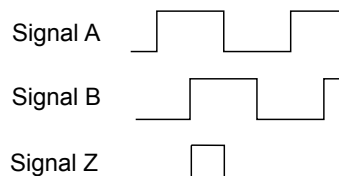

Signal name	CONN-CONIN-12F, connector pin no.
Excitation +	12
Excitation GND (0 V)	10
Signal A	5
Signal \bar{A}	6
Signal B (A + 90°)	8
Signal B	1
Signal Z (reference pulse)	3
Signal \bar{Z}	4
Fault detection signal \bar{U}_{as}	7
Shield	Housing

View to sensor connector

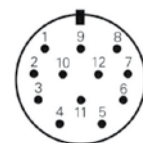

CONN-CONIN-12F

POSIWIRE®

HSSI

Absolute SSI Encoder



Signal conditioner HSSI Absolute encoder synchronous serial 	Excitation voltage	10 ... 30 V DC
	Excitation current	100 mA
	Interface	Standard SSI
	Lines / drivers	Clock and data / RS422
	Code	Gray
	Resolution	12 + 12 Bit
	3 dB cutoff frequency	500 kHz
	Control input	$\overline{\text{Direction}}$
	Preset key	Zero adjustment with optical response
	Alarm output	Alarm bit (SSI option), warning bit
	Status LED	Green = OK, red = alarm
	Connection	Cable or 12 pin male socket

Data format	Resolution	Clock												
		T1	T2	T3	...	T12	T13	...	T21	T22	T23	T24	T25	T26
		Data bits												
24 bit	M11	M10	M9	...	M0	S11	...	S3	S2	S1	S0	0		

Mx = multiturn bits, Sx = singleturn bits

Transmission rate	Cable length	Baud rate	Note: Extension of the cable length will reduce the maximum transmission rate.
	< 50 m	< 400 kHz	
	< 100 m	< 300 kHz	
	< 200 m	< 200 kHz	
	< 400 m	< 100 kHz	

Signal wiring	Signal name	Color	Connector pin no.
	Excitation +	White	8
	Excitation GND (0 V)	Brown	1
	CLOCK	Yellow	3
	$\overline{\text{CLOCK}}$	Green	11
	DATA	Pink	2
	$\overline{\text{DATA}}$	Grey	10
	$\overline{\text{Direction}}$ *	Blue	5
	0 V Signal output	Black	12

* Excitation + = cw increasing code, 0 V = cw decreasing code

Connection

View to sensor
connector

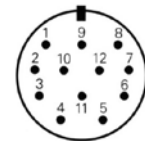

CONN-CONIN-12F

POSIWIRE®

HPROF

Absolute Profibus Encoder



Interface HPROF

Absolute encoder
Profibus



Excitation voltage	10 ... 30 V DC
Excitation current	250 mA
Interface	RS485
Protocol	Profibus DP with encoder profile C2
Resolution	12 (10 ... 14) + 12 bit
Output code	Binary
Baud rate	Automatically selected between 9,6 kBaud and 12 MBaud
Programmability	Resolution, preset, direction
Integrated special functions	Velocity, acceleration, operating time
Bus terminating resistor	Selectable via DIP switch
Connection	Bus cover with T manifold
EMC	EN 61326: class A

Signal wiring

Signal name	Cable terminal no. (bus cover)
U _B in	1
0V in	2
U _B out	3
0V out	4
B in	5
A in	6
B out	7
A out	8

POSIWIRE®

HINT

Absolute Interbus Encoder



Interface HINT Absolute encoder Interbus 	Excitation voltage	10 ... 30 V DC
	Excitation current	250 mA
	Interface	Interbus, ENCOM profile K3 (configurable), K2
	Output code	32 Bit binary
	Baud rate	500 kBaud
	Data refresh	Every 600 µs
	Resolution	12 (10 ... 14) + 12 bit
	Programmability	Direction, preset, offset, resolution
	Connection	Bus cover with T manifold
	EMC	EN 50081-2, EN 50082-2

Data format Interbus K2/K3		Differential signals (RS485) ENCOM profile K3, K2, 32 Bit, binary process data				
	DT-Format	Supi address	0	1	2	3
	(according to the Phoenix company)	Byte No.	3	2	1	0
	ID code K2	36 H (= 54 dec.)				
	ID code K3	37 H (= 55 dec.)				

Signal wiring	Signal name	Cable terminal no. (bus cover)
		U _B +
	GND	2
	DI1	3
	$\overline{DI1}$	4
	DO1	5
	$\overline{DO1}$	6
	DO2	7
	$\overline{DO2}$	8
	DI2	9
	$\overline{DI2}$	10
	RBST	11
	GND	12

POSIWIRE®
HDEV
Absolute DeviceNet Encoder



Interface HDEV Absolute encoder DeviceNet 	Excitation voltage	10 ... 30 V DC
	Excitation current	250 mA
	Interface	CAN highspeed according to ISO/DIS 11898 CAN specification 2.0 A (11 bit identifier)
	Protocol	DeviceNet according rev. 2.0, programmable encoder
	Resolution	12 (10 ... 14) + 12 bit
	Output code	Binary
	MAC-ID	Selectable via DIP switch
	Date refresh	Every 5 ms
	Baud rate	Selectable via DIP switch: 125 kBaud, 250 kBaud, 500 kBaud
	Programmability	Resolution, preset, direction
	Bus terminating resistor	Selectable via DIP switch
	Connection	Bus cover with T manifold
	EMC	EN 50081-2, EN 50082-2

Recommended transmission	Characteristic impedance	135 ... 165 Ω (3 ... 20 MHz)
	Operating capacity	< 30 pF
	Loop resistance	< 110 Ω/km
	Wire diameter	> 0.63 mm
	Wire width	> 0.34 mm ²

Transmission rate	Segment length	Kbit/s
	500 m	125
	250 m	250
	100 m	500

Signal wiring	Signal name	Cable terminal no. (bus cover)
	U _b in	1
	0V in	2
	CAN-L	3
	CAN-H	4
	Drain	5
	Drain	6
	CAN-H	7
	CAN-L	8

POSIWIRE®
HCAN/HCANOP
Absolute CAN / CANopen Encoder



Interface HCAN/HCANOP Absolute encoder CANopen/CAN Layer 2 	Excitation voltage	10 ... 30 V DC
	Excitation current	250 mA
	Interface	CAN highspeed according to ISO/DIS 11898
	Protocol	CANopen according DS301 with encoder profile DSP406, programmable encoder according class C2
	Resolution	12 (10 ... 14) + 12 bit
	Output code	Binary
	Data refresh	Every millisecond (selectable), on request
	Baud rate	Selectable 10 up to 1000 kbit/s
	Base identifier	Selectable via DIP switch
	Programmability	CANopen: direction, resolution, preset, offset CAN L2: direction, limit values
	Integrated special functions	CANopen: velocity, acceleration, rotary axis, limit values CAN L2: direction, limit values
	Connection	Bus cover with T manifold
	EMC	EN 50081-2, EN 50082-2

Signal wiring	Signal name	Cable terminal no. (bus cover)
	U _B in	1
	0V in	2
	CAN in – (dominant L)	3
	CAN in + (dominant H)	4
	CAN GND in	5
	CAN GND out	6
	CAN out + (dominant H)	7
	CAN out – (dominant L)	8
	0V out	9
	U _B out	10