

 **PTM29**

High-precision inclination sensor with robust, compact stainless steel housing



- Measurement range up to $\pm 180^\circ$
- Resolution up to 0.001°
- Protection class up to IP69
- Hermetically sealed stainless steel housing
- Longitudinal water barrier; potted electronics
- Wear-free MEMS technology, shock resistant

Product versions



Analog output

V / mA



Digital output CAN

CAN



PTM29 - Inclination sensor in MEMS technology
Version with analog output

Specifications

| | | | Order options |
|---|--|----------|---|
| Number and orientation of inclination axes | Inclination in X axis, orientation 1A Inclination in X axis, orientation 1B Inclination in X axis, orientation 1C Inclination in X and Y axes, orientation 2A Inclination in X and Y axes, orientation 2B Inclination in X and Y axes, orientation 2C | 1 | 1A 1B 1C 2A 2B 2C |
| Measurement range | ±5 ... 180° (selectable in 5° increments) | 2 | 5 ... 180 |
| Output | Voltage 0.5 ... 4.5 V (U _B = 24 V) Voltage 0.5 ... 10 V (on request) Voltage 0.5 ... 4.5 V (U _B = 5 V) (on request) Current 4 ... 20 mA, 3 wire (on request) | 3 | U8 U2 (on request) U6 (on request) I1 (on request) |
| Signal characteristics | Increasing signal for CW inclination Increasing signal for CCW inclination | 4 | CW CCW |
| Resolution | 0.005° (measurement range ±180°) 0.001° (measurement range ±5°) | | |
| Linearity | ±0.05° (up to ±30°) ±0.1° (up to ±60°) ±0.2° (up to ±180°) | | |
| Housing material | Stainless steel EN 1.4404 (AISI 316L) | | |
| Mounting | Screws M4: DIN 912, DIN 6912, DIN 7984 | | |
| Protection class | up to IP69 | | |
| Output delay | 0.1 s ... 10 s / 90% | 5 | T0.1 ... T10.0 |
| Connection | Cable, standard length 2 m | 6 | KAB2M |
| Shock | DIN EN 60068-2-27:2010, 100 g/11 ms, 100 shocks | | |
| Vibration | DIN EN 60068-2-6:2008, 20 g 10 Hz-2 kHz, 10 cycles | | |
| Temperature range | -40° ... +85°C | | |
| Weight | approx. 80 g (without cable) | | |
| EMC | DIN EN 61326-1:2013 | | |

Order code

| | | | | | | | | | | | | |
|-------|---|----------|---|----------|---|----------|---|----------|---|----------|---|----------|
| PTM29 | - | 1 | - | 2 | - | 3 | - | 4 | - | 5 | - | 6 |
|-------|---|----------|---|----------|---|----------|---|----------|---|----------|---|----------|

Order example: PTM29 – 1A – 180 – U8 – CW – T1.0 – KAB2M



PTM29 - Inclination sensor in MEMS technology
Version with digital output CAN

Specifications

| | | Order options |
|--------------------------|--|----------------------------|
| Output | CANopen SAE J1939 | 1 CANOP CANJ1939 |
| Measurement range | ±180° | |
| Resolution | ≥0.01° Adjustable by the user | |
| Linearity | ±0.05° (up to ±30°) ±0.1° (up to ±60°) ±0.2° (up to ±180°) | |
| Housing material | Stainless steel EN 1.4404 (AISI 316L) | |
| Mounting | Screws M4: DIN 912, DIN 6912, DIN 7984 | |
| Protection class | up to IP69 | |
| Output delay | 0.1 s ... 10 s / 90%, configurable | |
| Connection | Cable 0.3 m with connector M12, 5 pin | 2 KAB0,3M – M12/CAN |
| Shock | DIN EN 60068-2-27:2010, 100 g/11 ms, 100 shocks | |
| Vibration | DIN EN 60068-2-6:2008, 20 g 10 Hz-2 kHz, 10 cycles | |
| Temperature range | -40° ... +85°C | |
| Weight | approx. 80 g (without cable) | |
| EMC | DIN EN 61326-1:2013 | |

Order code

PTM29 – **1** – **2**

Order example: PTM29 – CANOP – KAB0,3M – M12/CAN

Dimensions

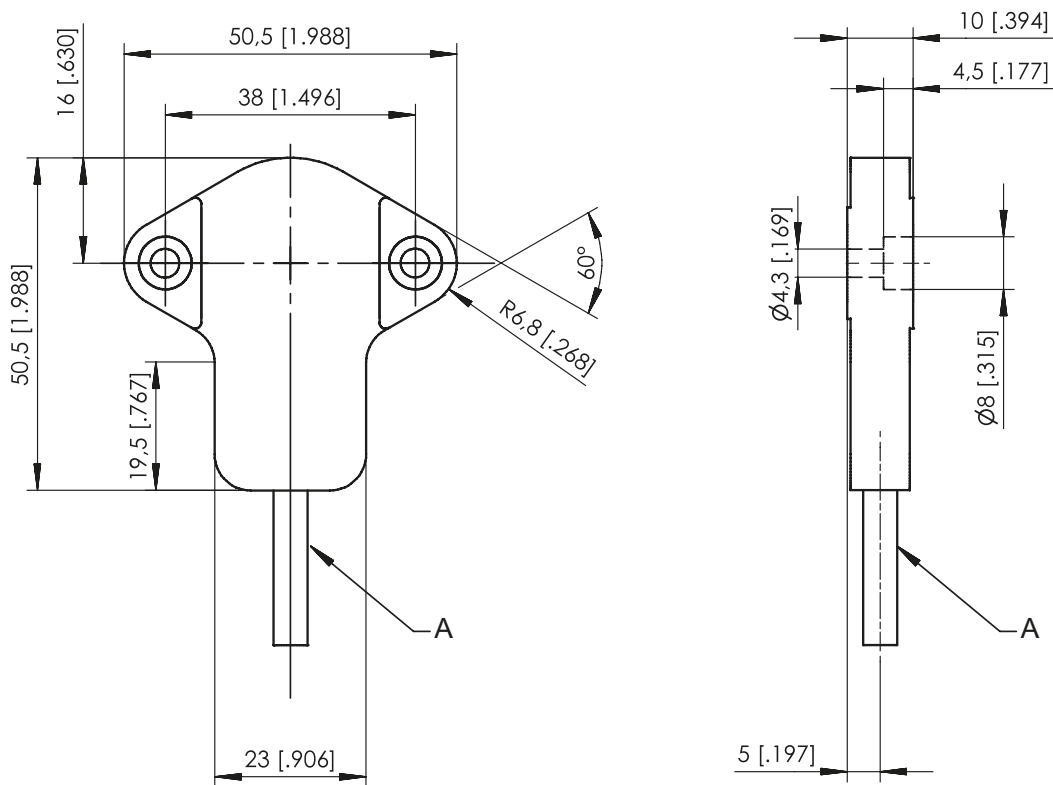

A – Cable

Dimensions in mm [inch].

Dimensions informative only.

For guaranteed dimensions consult factory.

Output specification

Analog output

| | | |
|--|-------------------------|---|
| U2 Voltage output 0.5 ... 10 V  | Excitation voltage | 8 ... 36 V DC |
| | Excitation current | typical 12 mA max. 16 mA |
| | Output voltage | 0.5 ... 10 V DC |
| | Output current | 2 mA max. |
| | Measuring rate | 1 kHz standard |
| | Stability (temperature) | $\pm 50 \times 10^{-6}$ / °C f.s. (typical) |
| | Protection | Reverse polarity, short circuit |
| | Operating temperature | -40 ... +85 °C |
| | EMC | DIN EN 61326-1:2013 |

| | | |
|---|-------------------------|---|
| U8 Voltage output 0.5 ... 4,5 V  | Excitation voltage | 8 ... 36 V DC |
| | Excitation current | typical 12 mA max. 16 mA |
| | Output voltage | 0.5 ... 4,5 V DC |
| | Output current | 2 mA max. |
| | Measuring rate | 1 kHz standard |
| | Stability (temperature) | $\pm 50 \times 10^{-6}$ / °C f.s. (typical) |
| | Protection | Reverse polarity, short circuit |
| | Operating temperature | -40 ... +85 °C |
| | EMC | DIN EN 61326-1:2013 |

| | | |
|---|-------------------------|---|
| U6 Voltage output 0.5 ... 4.5 V  | Excitation voltage | 5 V DC ± 10 % |
| | Excitation current | typical 13 mA max. 16 mA |
| | Output voltage | 10 ... 90 % of the excitation voltage |
| | Output current | 2 mA max. |
| | Measuring rate | 1 kHz standard |
| | Stability (temperature) | $\pm 50 \times 10^{-6}$ / °C f.s. (typical) |
| | Protection | Reverse polarity, short circuit |
| | Operating temperature | -40 ... +85 °C |
| | EMC | DIN EN 61326-1:2013 |

| | | |
|--|-------------------------|--|
| I1 Current output 4 ... 20 mA, 3 wires  | Excitation voltage | 8 ... 36 V DC |
| | Excitation current | typical 32 mA max. 36 mA |
| | Load R _L | 500 Ω max. |
| | Output current | 4 ... 20 mA |
| | Measuring rate | 1 kHz standard |
| | Stability (temperature) | ±50 x 10 ⁻⁶ / °C f.s. (typical) |
| | Protection | Reverse polarity, short circuit |
| | Operating temperature | -40 ... +85 °C |
| | EMC | DIN EN 61326-1:2013 |

| Signal wiring | Output signals | Cable color |
|---------------|--------------------------------------|-------------|
| 1 axis | +U _B (excitation voltage) | brown |
| | Output X | white |
| | GND | blue |
| | Do not connect! | grey |

| Signal wiring | Output signals | Cable color |
|---------------|--------------------------------------|-------------|
| 2 axes | +U _B (excitation voltage) | brown |
| | Output X | white |
| | GND | blue |
| | OUTPUT Y | black |
| | Do not connect! | grey |

Digital output CANopen

| | | |
|--|-------------------------------|---|
| CANOP CANopen  | Communication profile | CANopen CiA 301, Slave |
| | Encoder profile | CiA 410, Profile „Inclinometer“ |
| | Configuration services | LSS, CiA Draft Standard 305 (Transmission rate, node ID) |
| | Error Control | Node guarding, Heartbeat, Emergency message |
| | Node ID | Adjustable via LSS or SDO, default: 127 |
| | PDO | 1 TxPDO, 0 RxPDO, no linking, static mapping |
| | PDO Modes | Event-/Time triggered, Remote-request, Sync cyclic/acyclic |
| | SDO | 1 Server, 0 Client |
| | Certified | yes |
| | Transmission rate | 125 kBit ... 1 Mbit, adjustable via LSS or SDO, default: 125 kBit |
| | Bus connection | M12 connector, 5 pin |
| | Bus, galvanic isolated | no |
| | Error Control Baudrate | 50 kBit/s ... 1 MBit/s configurable |
| | Transceiver | 24V-compliant, not isolated |
| | Internal termination resistor | 120 Ohm configurable |

| | | |
|-----------------------|-------------------------|---|
| Specifications | Excitation voltage | 8 ... 36 V DC |
| | Excitation current | 15 mA typical at 24 V DC 30 mA typical at 12 V DC 100 mA max. |
| | Measuring rate | 0.5 kHz standard |
| | Stability (temperature) | ± 0,2° (-20 ... +40 °C) ± 0,4° (-40 ... +85 °C) |
| | Repeatability | 1 LSB |
| | Operating temperature | -40 ... +85 °C |
| | Protection | Reverse polarity, short circuit |
| | EMC | DIN EN 61326-1:2013 |

| Signal wiring | Output signals | Connector pin no. |
|--|----------------|-------------------|
| Connector M12, 5 pin  View to the sensor connector | Shield | 1 |
| | Excitation + | 2 |
| | GND | 3 |
| | CAN-H | 4 |
| | CAN-L | 5 |

Digital output SAE J1939

| | | |
|---|-------------------------------|--|
| CANJ1939 SAE J1939  | CAN Specification | ISO 11898, Basic and Full CAN 2.0 B extended message format with 29-bit identifier |
| | Transceiver | 24V-compliant, not isolated |
| | Communication profile | SAE J1939, 29-bit identifier |
| | Transmission rate | 250 kBit/s |
| | Internal termination resistor | 120 Ω |
| | Address | Default 247d, configurable |

| NAME - Unique device identifier | Name Fields | Remark | Field value | Size [Bit] | Byte order | Byte value |
|---------------------------------|---------------------------|-------------------|-------------|------------|--------------|------------|
| | Arbitrary Address Capable | No | 0 | 1 | Byte 8 (MSB) | 00h |
| | Industry Group | Global | 0 | 3 | | |
| | Vehicle System instance | | 0 | 4 | | |
| | Vehicle System | Non specific | 7Fh | 7 | Byte 7 | FEh |
| | Reserved | | 0 | 1 | | |
| | Function | Non specific | FFh | 8 | Byte 6 | FFh |
| | Function Instance | | 0 | 5 | Byte 5 | 00 |
| | ECU Instance | | 0 | 3 | | |
| | Manufacturer | Manufacturer Code | 145h | 11 | Byte 4 | 28h |
| | | | | | | Byte 3 |
| | | Identity Number | n..nh | 21 | | |
| | | | | | | Byte 2 |
| | | | | | Byte 1 | nnh |

| | | | |
|--|--------------------|-----------|--|
| Proprietary PGN - Manufacturer specific Parameter Group Numbers | Configuration data | PGN EFddh | Proprietary-A (PDU1 peer-to-peer) |
| | Process data | PGN FFnnh | Proprietary-B (PDU2 broadcast); nn Group Extension (PS) configurable |

| Specifications | | |
|----------------|-------------------------|---|
| | Excitation voltage | 8 ... 36 V DC |
| | Excitation current | 15 mA typical at 24 V DC 30 mA typical at 12 V DC, 100 mA max. |
| | Measuring rate | 0.5 kHz (asynchronous) |
| | Stability (temperature) | ± 0,2° (-20 ... +40 °C) ± 0,4° (-40 ... +85 °C) |
| | Repeatability | 1 LSB |
| | Operating temperature | -40 ... +85 °C |
| | Protection | Reverse polarity, short circuit |
| | EMV | DIN EN 61326-1:2013 |

| Signal wiring | Output signals | Connector pin no. |
|---|----------------|-------------------|
| Connector M12, 5 pin  <p>View to the sensor connector</p> | Shield | 1 |
| | Excitation + | 2 |
| | GND | 3 |
| | CAN-H | 4 |
| | CAN-L | 5 |

PTM29 - Characteristic of the linear output and axis orientation

Sensor position as shown equals 0°.

1 Measuring axis

Axis orientation
1A

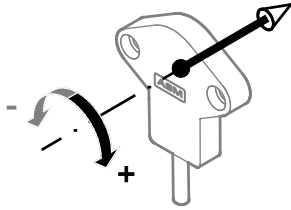

Axis orientation
1B

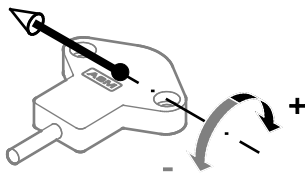

Axis orientation
1C

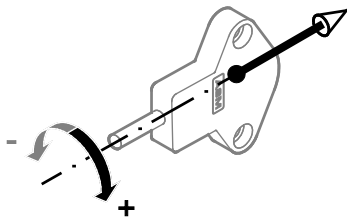

2 Measuring axes

Axis orientation
2A

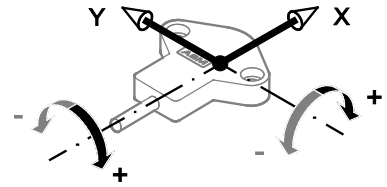

Axis orientation
2B

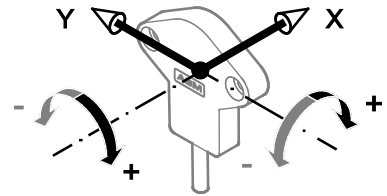

Axis orientation
2C

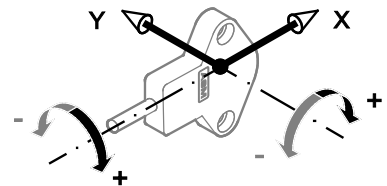

Output signal

